



# MKH 8060

Quick Guide  
Kurzanleitung  
Guide rapide  
Guía rápida  
Guía de inicio rápido  
Guia rápido  
Beknopte handleiding  
Krótka instrukcja obsługi  
Snabbguide

Kort vejledning  
Pikaohje  
Γρήγορος οδηγός  
Kisa Kilavuz  
Краткая инструкция  
快速指南  
快速使用指南  
クイックガイド  
퀵 가이드

**SENNHEISER**



[www.sennheiser.com/documentation](http://www.sennheiser.com/documentation)



[www.sennheiser.com/download](http://www.sennheiser.com/download)

Sennheiser electronic SE & Co. KG

Am Labor 1, 30900 Wedemark, Germany  
[www.sennheiser.com](http://www.sennheiser.com)

Publ. 05/26, 402227/A02

## In the box

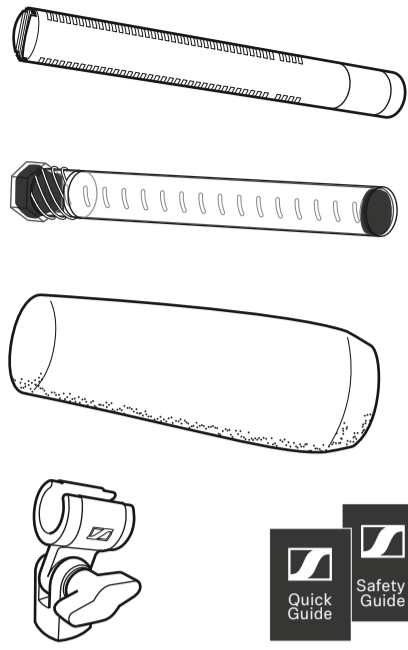

## Setup

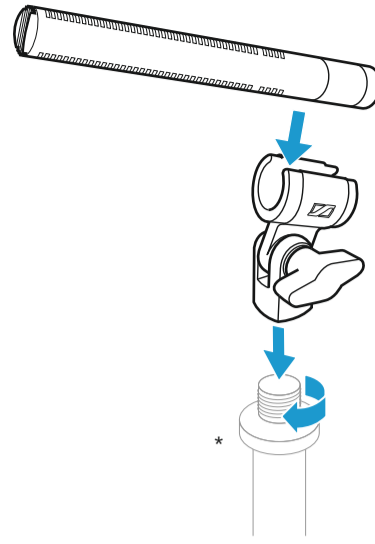

\* not included

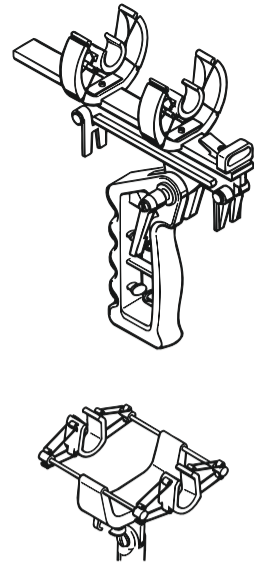

MZS 20-1\*

MZS 40\*

\* not included

## Overview

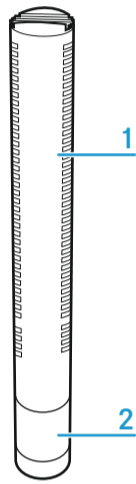

- 1 Microphone head
- 2 XLR-Modul

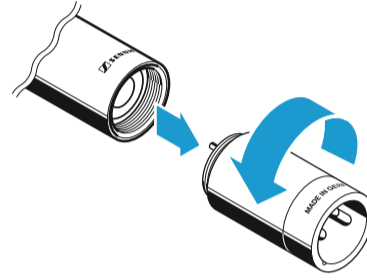

See MKH 8000 series microphone and accessories overview

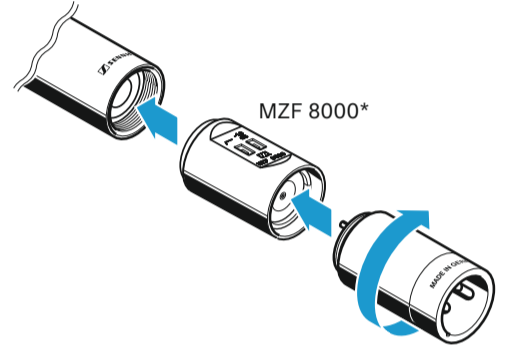

\* not included

## Transport / Storage

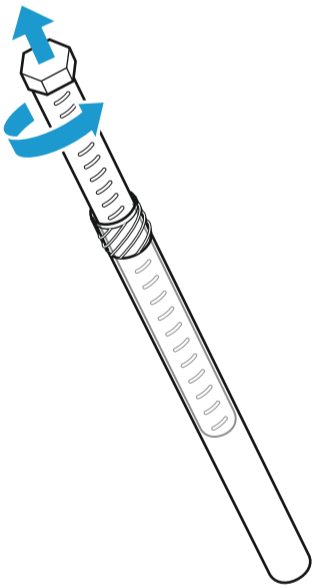

## Cleaning

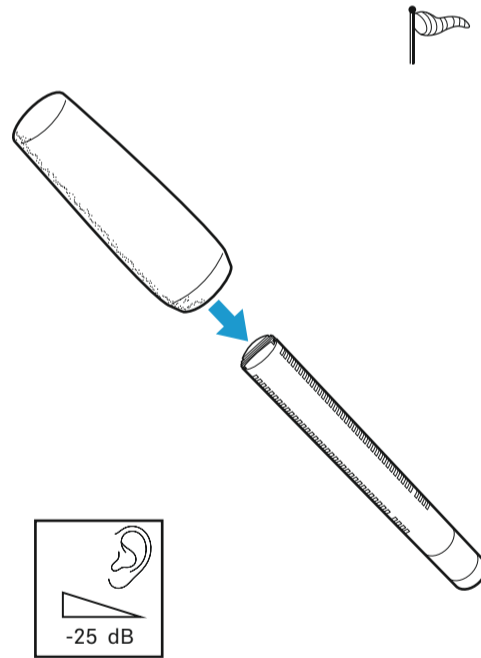
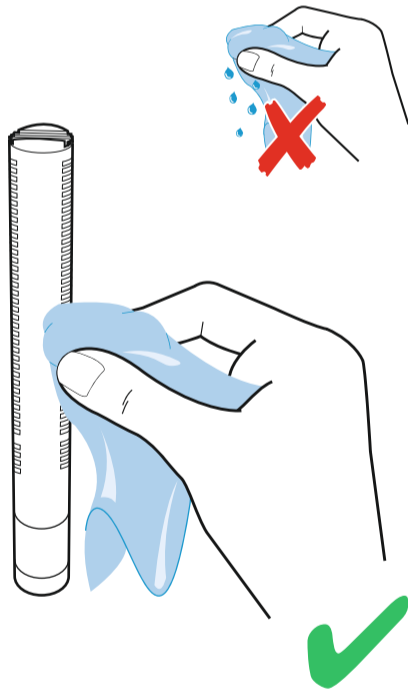

-25 dB

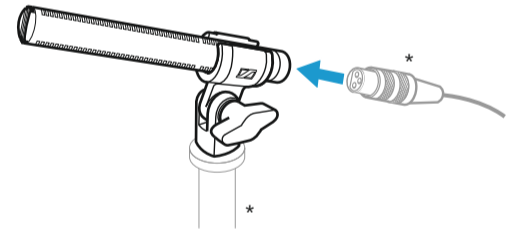

\* not included

## Polar pattern and frequency response

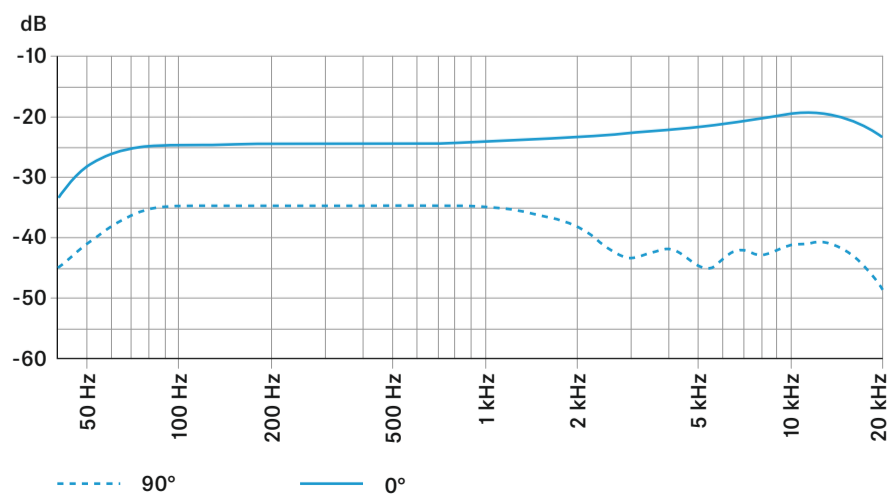
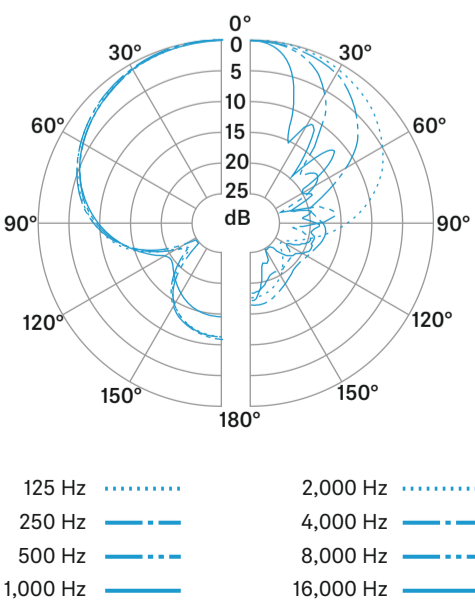

## Specifications

Pick-up pattern	super-cardioid/lobar
Frequency response	50 - 25,000 Hz
Sensitivity	-24 dBV/Pa (63 mV/Pa)
Max. SPL	129 dB
Equivalent noise level	11 dB(A) 23 dB (CCIR)
Nominal impedance	25 Ω
Min. terminating impedance	2 kΩ
Phantom powering	48 V ± 4 V (P48, IEC 61938)
Current consumption	3.3 mA
Diameter	19 mm
Length	145 mm with MZX 8000 178 mm
Weight	80 g with MZX 8000 112 g
Operating temperature	-10 °C to 60 °C (14 °F to 140 °F)

# MKH 8000 Series

## Microphone and accessories overview



**MKH 8020**  
RF-condensor mic, omni



**MKH 8030**  
RF-condensor mic, fig-of-eight



**MKH 8040**  
RF-condensor mic, cardioid



**MKH 8050**  
RF-condensor mic, super-cardioid



**MKH 8090**  
RF-condensor mic, cardioid, wide cardioid

### Delivery included accessories



**MZX 8000**  
XLR module



**MZQ 8000**  
Mic clamp



**MZW 8000 / MZW 8030**  
Foam windshield for  
MZW 8030 for MKH 8030, all others: MZW 8000

### Optional accessories



**MZF 8000 II**  
Screw filter module MZF 8000 II at suitable place  
between microphone head and XLR module.



**MZL 8003**  
Connecting cable, 3 m



**MZL 8010**  
Connecting cable, 10 m

### Microphone stand



Microphone stand  
Vertical bar & foot stand



**MZE 8060 / MZE 8120**  
Extension tube 0.60 m / 1.20 m



**MZGE 8000**  
Tube connector



**MZEF 8060 / MZEF 8120**  
Vertical bar 0.60 m / 1.20 m



**MZFS 8000**  
Floor stand

### Table / Ceiling mounting



**MZT 8000**  
Table stand



**MZH 8042**  
Goose neck



**MZH 8000**  
Ceiling mount



**MZQ 8001**  
Mini clip



**MZG 8000**  
Swivel joint



**MZS 31**  
Shockmount

### Shotgun microphones

#### Delivery included accessories



**MKH 8060**  
RF-condensor mic, short shotgun



**MZX 8000**  
XLR module



**MZW 8060 / MZW 8070**  
Foam windshield  
MZW 8060 for MKH 8060  
MZW 8070 for MKH 8070



**MKH 8070**  
RF-condensor mic, long shotgun



**MZQ 8060**  
Mic clamp

#### Optional accessories



**MZF 8000 II**  
Screw filter module MZF 8000 II at suitable place  
between microphone head and XLR module.



**MZL 8003**  
Connecting cable, 3 m



**MZL 8010**  
Connecting cable, 10 m



### Outdoor use

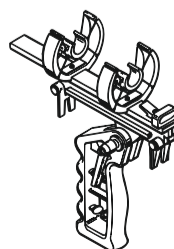

**MZS 20-1**  
Pistol grip

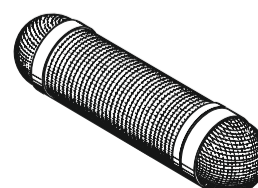

**MZW 20-1 / MZW 80**  
short windshield basket / long windshield basket

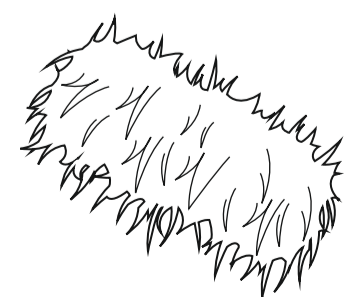

**MZH 20-1 / MZH 80**  
Wind muff for MZW 20-1 / for MZW 80