



MZA 900 P MZA 900-4

Phantom power adaptor

Quick Guide

Kurzanleitung

Guide de démarrage rapide

Guida rapida

Instrucciones resumidas

Instruções resumidas

Beknopte gebruiksaanwijzing

Krótką instrukcja obsługi

Snabbguide

Kort vejledning

Pikaohje

Σύντομες οδηγίες

Kısa Kılavuz

Краткая инструкция

快速指南

快速使用指南

クイックガイド

요약 안내서



SENNHEISER

In the box

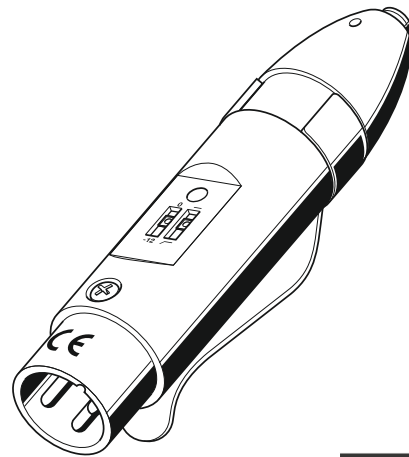

Connecting a microphone

A

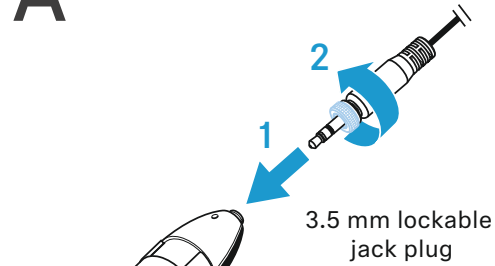

B

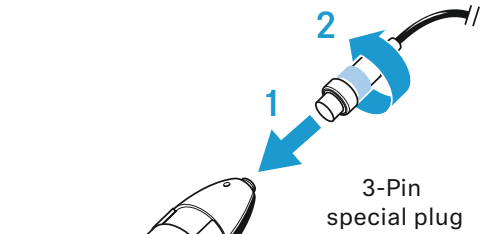

Connecting to a phantom powered microphone input

i Microphone input 10 – 52 V, phantom powering (P12 – P48)

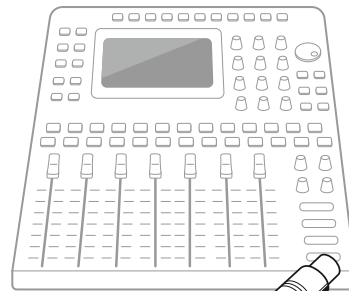

not included

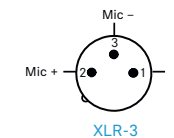
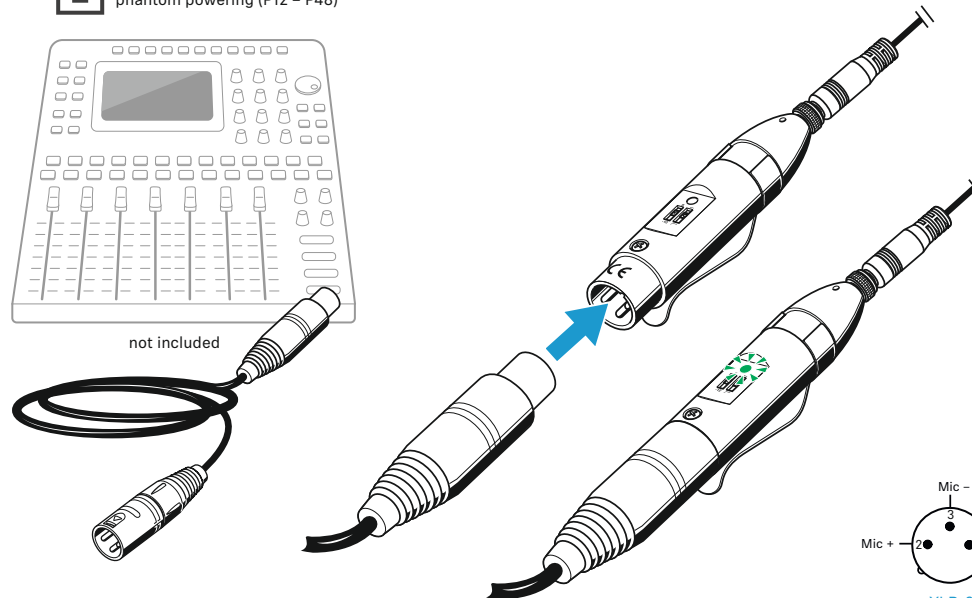

Swapping to wireless transmitter

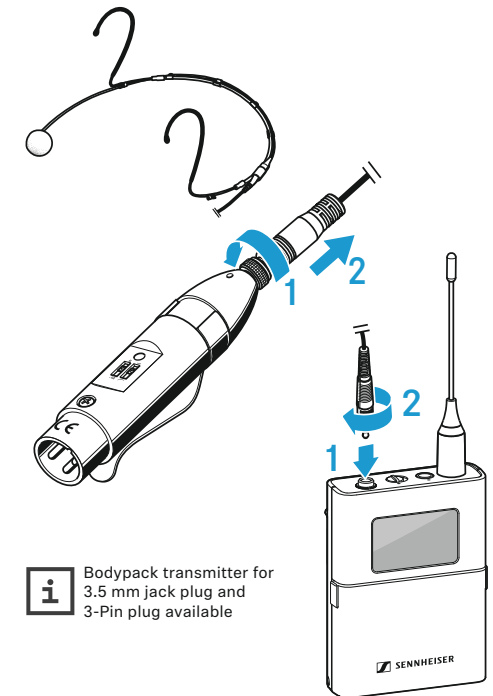

i Bodypack transmitter for 3.5 mm jack plug and 3-Pin plug available

*not included



www.sennheiser.com/download

Sennheiser electronic SE & Co. KG

Am Labor 1, 30900 Wedemark, Germany
www.sennheiser.com

Printed in Germany, Publ. 09/24, 402225/A01

Settings / operation

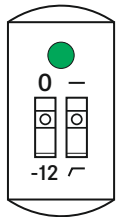
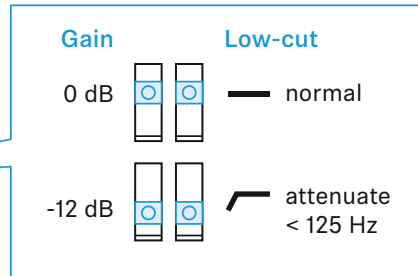
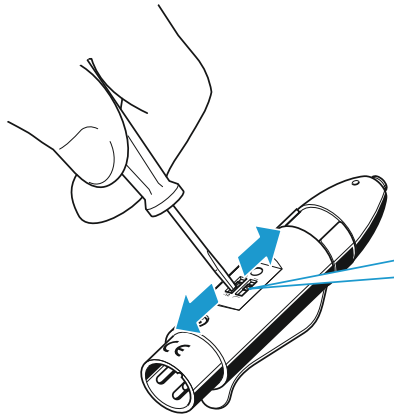

LED

- normal operation: properly powered, no over-modulation
- flashing: over-modulation of the microphone or overloading of the MZA 900 P's output
- solid: cable defective

Using as a cable tester

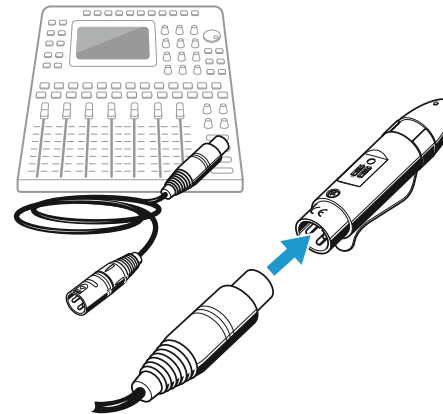

LED

- cable is OK
- one signal wire broken
- one signal wire short-circuited to the shielding
- both signal wires broken
- shielding interrupted
- both signal wires short-circuited to the shielding

Attaching to clothing

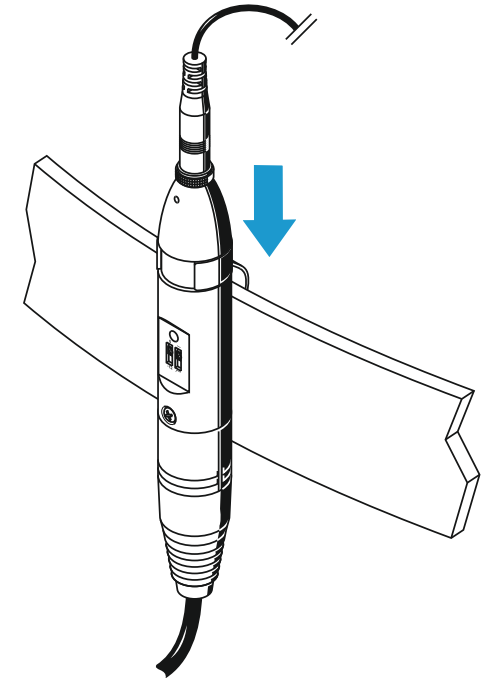

Connector assignment

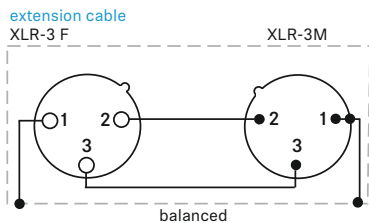
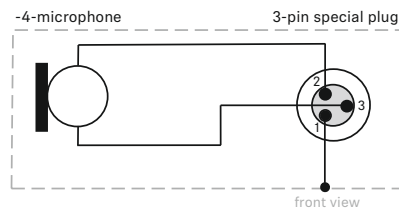
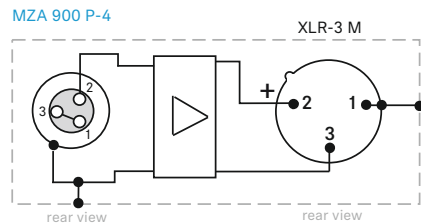
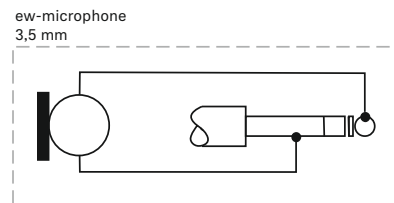
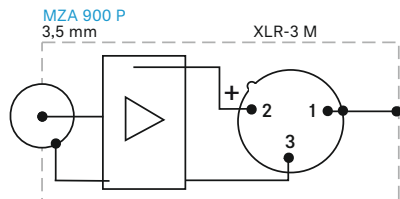

Cleaning

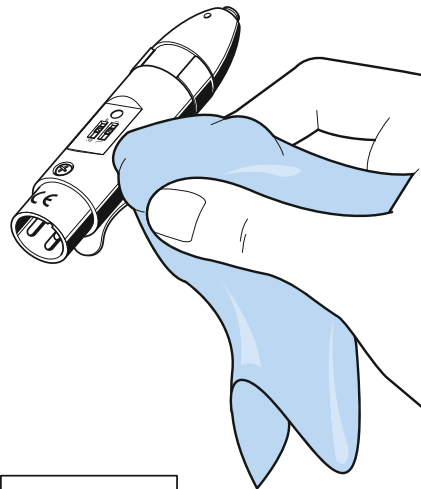

Specifications

MZA 900 P | MZA 900 P-4

Frequency response	20 Hz - 20,000 Hz
Pre-attenuation, switchable	0/-12 dB
Roll-off filter, switchable	125 Hz (- 3 dB), 12 dB/oct
Max. output voltage at	
0 dB pre-attenuation	1.8 V (P48) 0.6 V (P12)
-12 dB pre-attenuation	0.45 V (P12 - P48)
Noise voltage at the output	CCIR: 12µV (0/-12 dB) A: 3µV (0/-12 dB)
Output impedance	100 Ω
Min. load impedance at	
0 dB pre-attenuation	5kΩ (P12 - P48)
-12 dB pre-attenuation	2 kΩ (P12 - P48)

Power supply	P12 - P48 [10-52 V] 2.6 - 2.8 mA
Connector	XLR-3M
Input socket	
MZA 900 P	3.5 mm jack socket, lockable
MZA 900 P-4	3-pin special plug

General data

Temperature range	
Operation	-20 °C to +60 °C
Storage	-20 °C to + 70°C
Dimensions	∅ 19/22 mm, L 100 mm
Humidity range	< 95% r.h.
Weight	60 g