



# MZA 900 P MZA 900-4

Phantom power adaptor

Quick Guide	Kort vejledning
Kurzanleitung	Pikaohje
Guide de démarrage rapide	Σύντομες οδηγίες
Guida rapida	Kısa Kılavuz
Instrucciones resumidas	Краткая инструкция
Instruções resumidas	快速指南
Beknopte gebruiksaanwijzing	快速使用指南
Krótką instrukcja obsługi	クイックガイド
Snabbguide	요약 안내서

SENNHEISER

## In the box

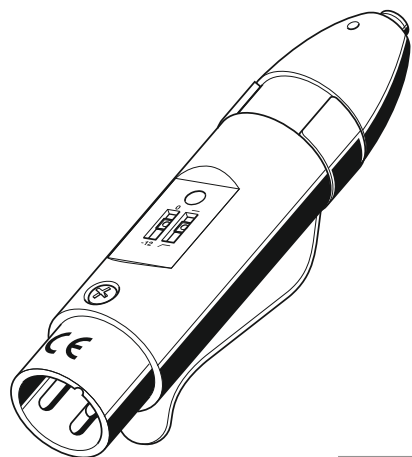

## Connecting a microphone

### A

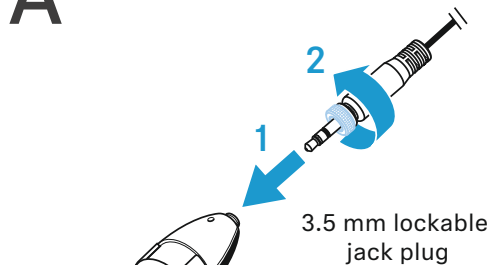

3.5 mm lockable  
jack plug

### B

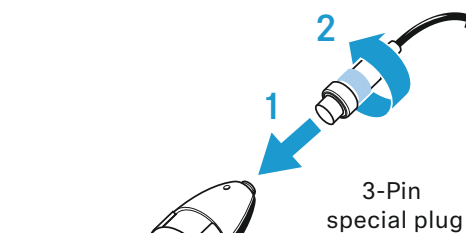

3-Pin  
special plug

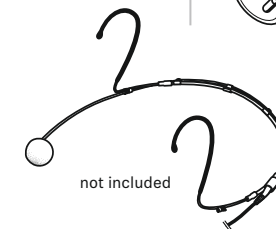

not included

## Connecting to a phantom powered microphone input

**i** Microphone input 10 – 52 V,  
phantom powering (P12 – P48)

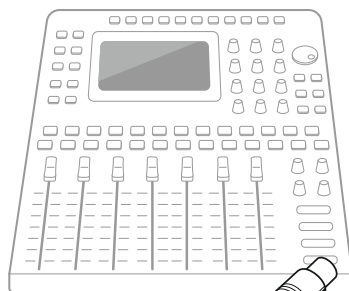

not included

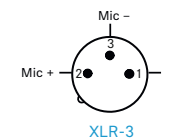
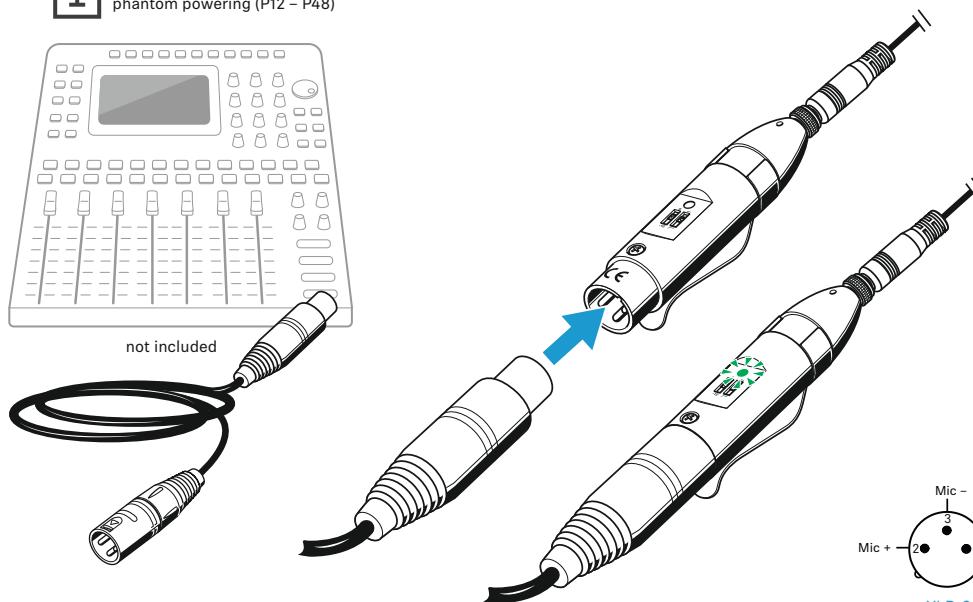

XLR-3

## Swapping to wireless transmitter

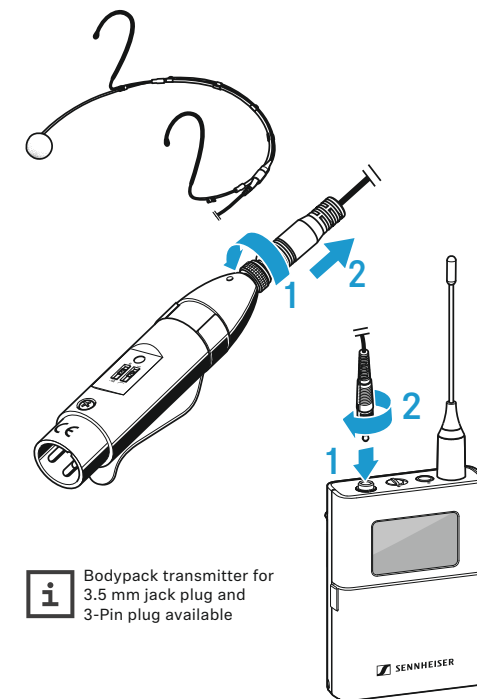

**i** Bodypack transmitter for  
3.5 mm jack plug and  
3-Pin plug available

\*not included



[www.sennheiser.com/documentation](http://www.sennheiser.com/documentation)



[www.sennheiser.com/download](http://www.sennheiser.com/download)

Sennheiser electronic SE & Co. KG

Am Labor 1, 30900 Wedemark, Germany  
[www.sennheiser.com](http://www.sennheiser.com)

Publ. 05/26, 402225/A02

## Settings / operation

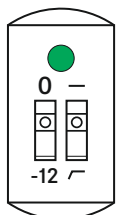
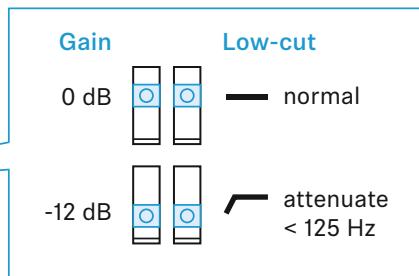
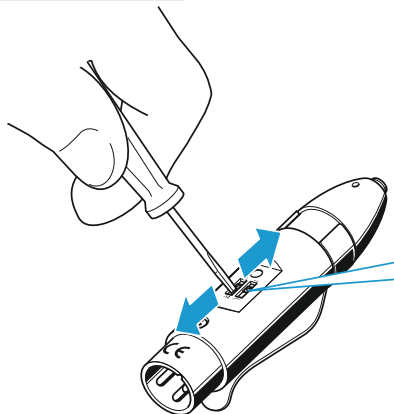

### LED

- normal operation: properly powered, no over-modulation
- flashing: over-modulation of the microphone or overloading of the MZA 900 P's output
- solid: cable defective

## Using as a cable tester

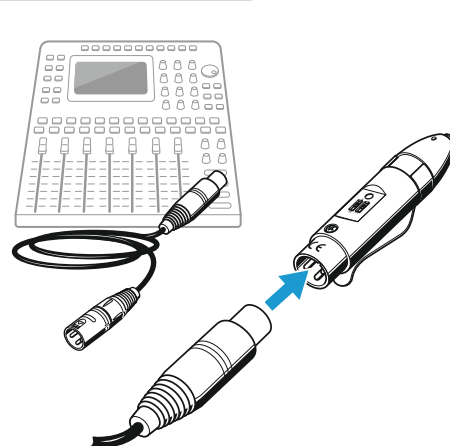

### LED

- cable is OK
- one signal wire broken
- one signal wire short-circuited to the shielding
- both signal wires broken
- shielding interrupted
- both signal wires short-circuited to the shielding

## Attaching to clothing

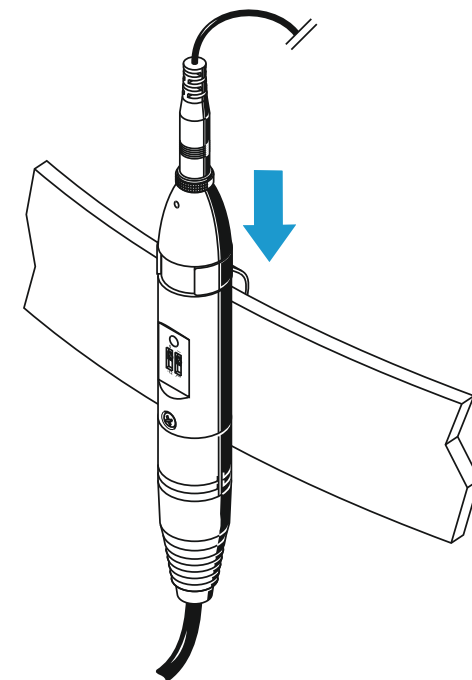

## Connector assignment

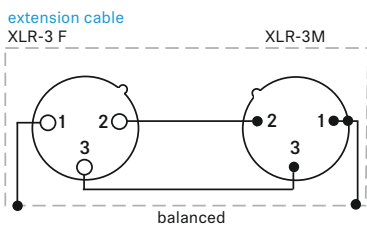
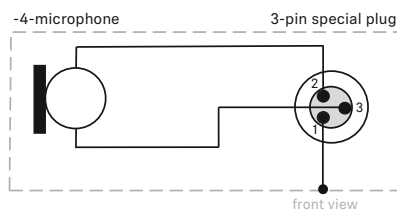
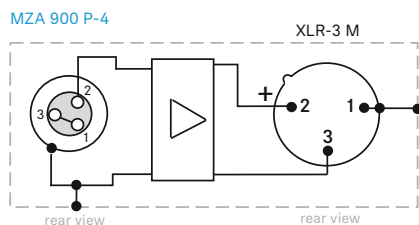
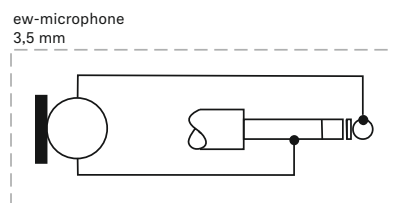
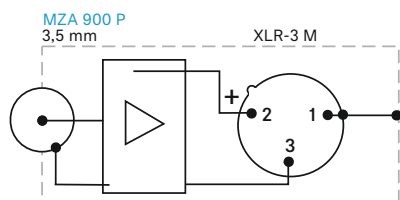

## Cleaning

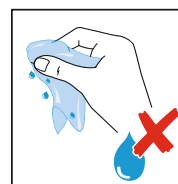
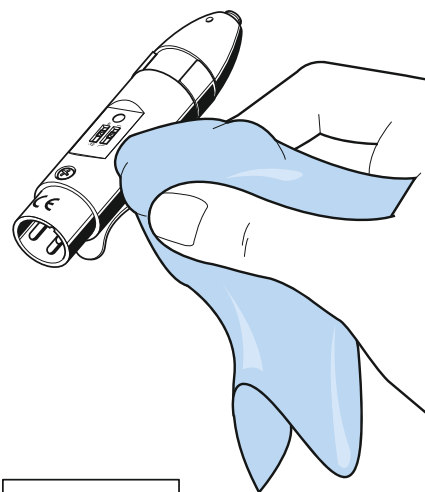

## Specifications

MZA 900 P   MZA 900 P-4	
Frequency response	20 Hz - 20,000 Hz
Pre-attenuation, switchable	0/-12 dB
Roll-off filter, switchable	125 Hz (- 3 dB), 12 dB/oct
Max. output voltage at	
0 dB pre-attenuation	1.8 V (P48)   0.6 V (P12)
-12 dB pre-attenuation	0.45 V (P12 - P48)
Noise voltage at the output	CCIR: 12µV (0/-12 dB) A: 3µV (0/-12 dB)
Output impedance	100 Ω
Min. load impedance at	
0 dB pre-attenuation	5 kΩ (P12 - P48)
-12 dB pre-attenuation	2 kΩ (P12 - P48)
Power supply	P12 - P48   10 - 52 V   2.6 - 2.8 mA
Connector	XLR-3M
Input socket	
MZA 900 P	3.5 mm jack socket, lockable
MZA 900 P-4	3-pin special plug

### General data

Temperature range	
Operation	-20 °C to +60 °C
Storage	-20 °C to +70 °C
Dimensions	∅ 19/22 mm, L 100 mm
Humidity range	< 95% r.h.
Weight	60 g