



www.sennheiser.com/documentation



www.sennheiser.com/download



e 965

Quick Guide
 Kurzanleitung
 Guide rapide
 Guida rapida
 Guía de inicio rápido
 Guia rápido
 Beknopte handleiding
 Krótka instrukcja obsługi
 Snabbguide

Kvikstartguide
 Pikaohje
 Γρήγορος οδηγός
 Kısa Kılavuz
 Краткая инструкция
 快速指南
 快速使用指南
 クイックガイド
 퀵 가이드

Sennheiser electronic SE & Co. KG

Am Labor 1, 30900 Wedemark, Germany
www.sennheiser.com

Publ. 04/26, 581340/A08

SENNHEISER

Setup

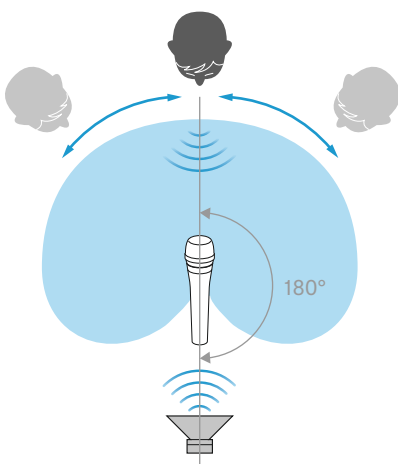
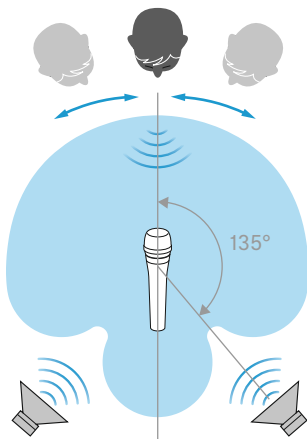
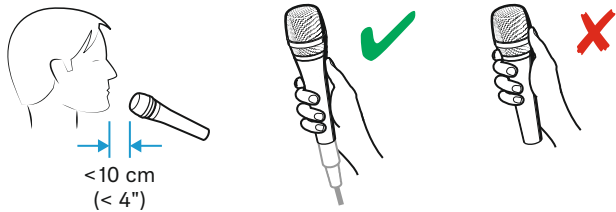
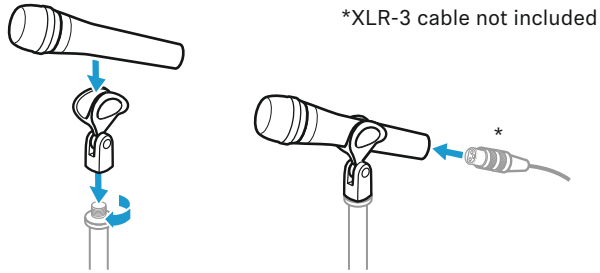

In the box

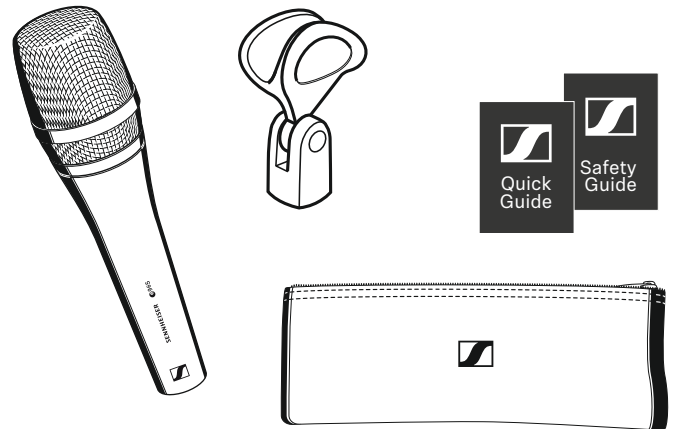

Overview

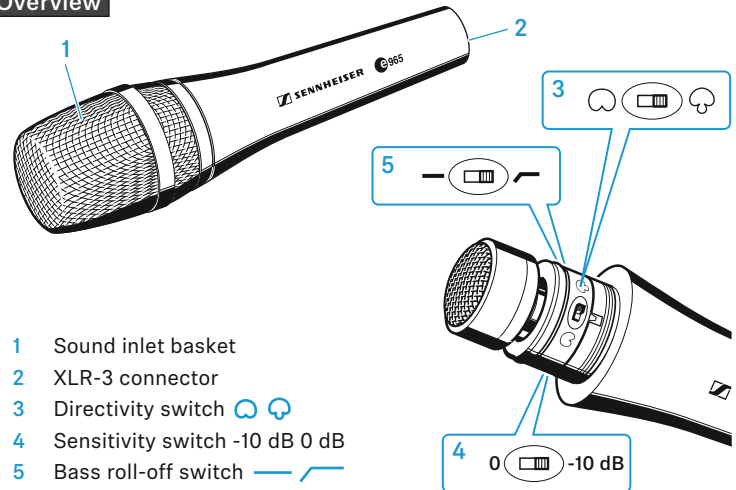

Accessory

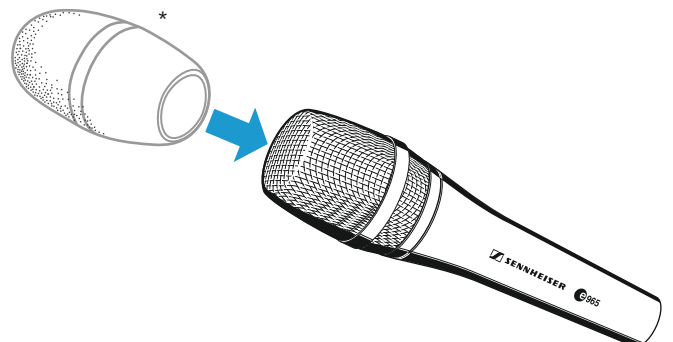

Cleaning

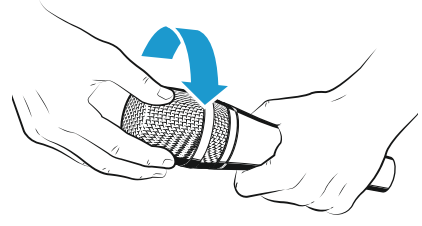
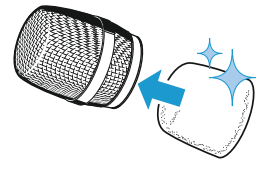
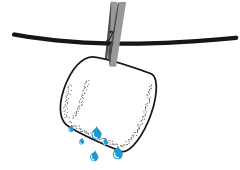
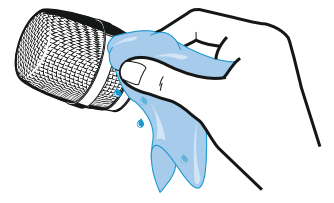
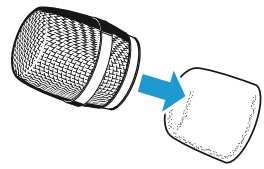
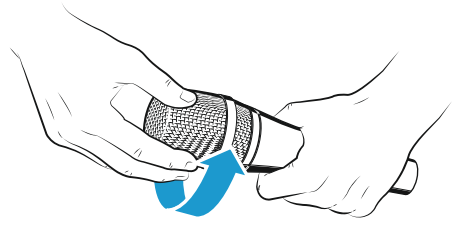

Connector assignment

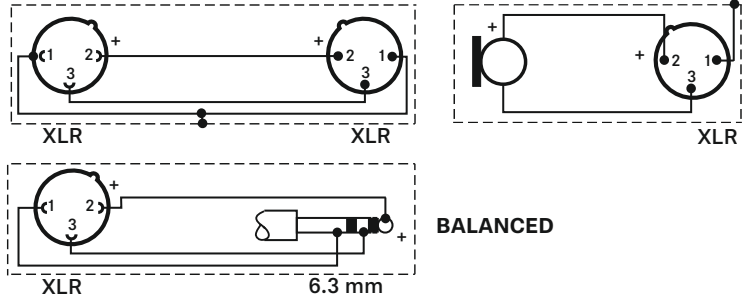

Specifications

Transducer principle	externally polarized dual diaphragm AF condenser microphone
Membran diameter	25.4 mm/1"
Frequency response	40 - 20,000 Hz
Pick-up pattern	cardioid/super-cardioid, switchable
Sensitivity (free field, at 1 kHz)	7 mV/Pa
with pre-attenuation	2.3 mV/Pa
Nominal impedance (at 1 kHz)	50 Ω
Min. terminating impedance	1 kΩ
Maximum sound pressure level (passiv)	142 dB
with pre-attenuation	152 dB
Equivalent noise level	21 dB (A)
Phantom powering	48 V / 3.5 mA
Connector	XLR-3
Temperature range	0 °C to +40 °C
Dimensions	∅ 48 x 199 mm
Weight	396 g

Polar pattern and frequency response

