

# CEHS-AV 04

## SD series

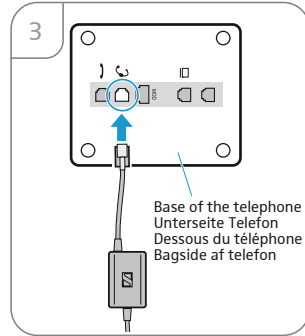

## D 10 series

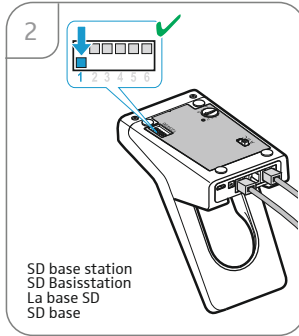
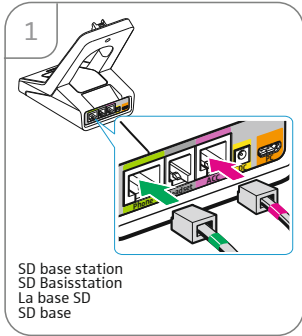
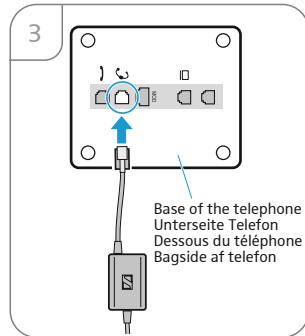
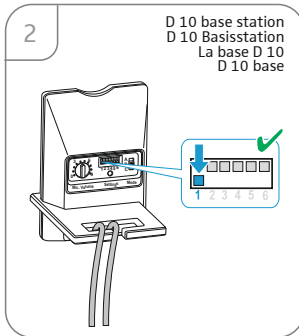
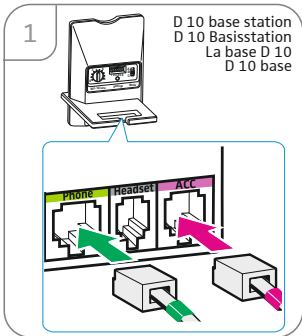

Sennheiser Communications A/S  
Industriparken 27, DK-2750 Ballerup, Denmark  
www.sennheiser.com | Printed in EU, Publ. 03/16, A05

EN

Adapter cable for electronic hook switch for Avaya & Grandstream phones  
▶ Before connecting the adapter cable, disconnect the base station from the mains.

\* AVAYA system software version 6.23 or higher is required

DE

Avaya & Grandstream-Adapterkabel für elektronische Fernabnehmer  
▶ Trennen Sie die Basisstation vom Netz, bevor Sie das Adapterkabel anschließen.

\* AVAYA System-Software Version 6.23 oder höher erforderlich

FR

Câble adaptateur Avaya & Grandstream pour décrocheur à distance électronique  
▶ Débranchez la base du secteur avant de raccorder le câble adaptateur.

\* AVAYA system software version 6.23 ou supérieure est requis

DA

Avaya & Grandstream adapterkabel til elektronisk rørløft  
▶ Sluk strømmen til basestationen før kabelmontering.

\*AVAYA systemsoftware version 6.23 eller højere krævet



## DW series

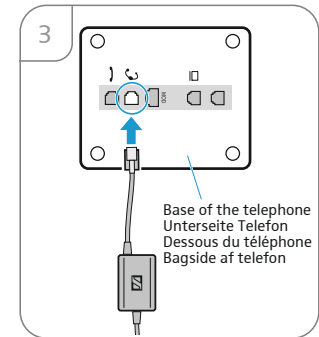
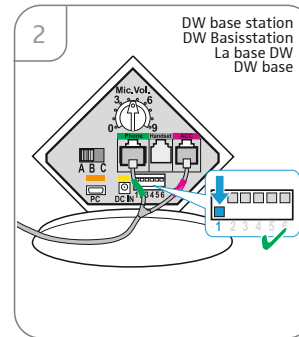
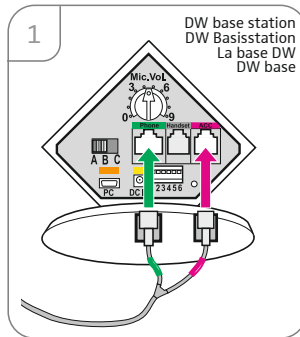

SD & D 10 series: see back page

## Statements regarding FCC and Industry Canada | Déclaration requise par la FCC et l'Industrie Canada

### FCC Declaration of Conformity (DoC)

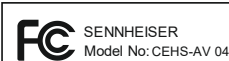

Sennheiser Electronic Corporation  
One Enterprise Drive • Old Lyme •  
CT 06371 • USA  
Tel: +1 (860) 434 9190, ext. 144  
Fax: +1 (860) 434 1759

We, declare the above device comply with the requirements of Federal Communications Commission.

This device complies with Part 15 subpart b of the FCC rules. Operation is subjected to the following two conditions:

- 1) This device may not cause harmful interference, and
- 2) This device must accept any interference received, including interference that may cause undesired operation.

Responsible Party: Markus Warlitz

This device complies with Part 15 of the FCC rules and RSS-210 of Industry Canada. Operation is subject to the following two conditions:

- 1) This device may not cause harmful interference, and
- 2) This device must accept any interference received, including interference that may cause undesired operation.

This equipment has been tested and found to comply with the limits for a Class B digital device, pursuant to part 15 of the FCC Rules and RSS-210 of Industry Canada. These limits are designed to provide reasonable protection against harmful interference in a residential installation. This equipment generates, uses and can radiate radio frequency energy and, if not installed and used in accordance with the instructions, may cause harmful interference to radio communications.

However, there is no guarantee that interference will not occur in a particular installation. If this equipment does cause harmful interference to radio or television reception, which can be determined by turning the equipment off and on, the user is encouraged to try to correct the interference by one or more of the following measures:

- Reorient or relocate the receiving antenna.
- Increase the separation between the equipment and receiver.
- Connect the equipment into an outlet on a circuit different from that to which the receiver is connected.
- Consult the dealer or an experienced radio/TV technician for help.

Changes or modifications made to this equipment not expressly approved by Sennheiser electronic Corp. may void FCC authorization to operate this equipment. This Class B digital apparatus complies with Canadian ICES-003.

#### In compliance with:

USA	
Canada	ICES-003
Australia/New Zealand	

Cet appareil est conforme à la Partie 15 des réglementations de la FCC et à la norme CNR-210 d'Industrie Canada. L'utilisation de l'appareil doit respecter les deux conditions suivantes :

- 1) L'appareil ne doit pas produire d'interférences nuisibles, et,
- 2) il doit accepter toutes interférences reçues, y compris celles qui pourraient avoir des effets non désirés sur son fonctionnement.

Cet équipement a été testé et trouvé conforme aux limites définies pour un dispositif numérique de classe B, dans le cadre de la Partie 15 des réglementations de la FCC et de la norme CNR-210 d'Industrie Canada. Ces limites sont conçues pour offrir une protection raisonnable contre les interférences nocives pour une installation résidentielle.

Cet équipement produit, utilise et peut émettre une énergie haute fréquence et, s'il n'est pas installé et utilisé conformément aux instructions, provoquer des interférences gênantes pour les communications radio. Des risques d'interférences ne peuvent toutefois pas être totalement exclus dans certaines installations, même en cas de respect des instructions.

Dans le cas d'interférences gênantes pour la réception des émissions de radio ou télédiffusées (il suffit, pour le constater, d'allumer et d'éteindre l'équipement), l'utilisateur est invité à prendre l'une des mesures suivantes pour les éliminer :

- Réorienter ou déplacer l'antenne réceptrice.
- Eloigner l'équipement du récepteur.
- Brancher l'équipement sur une prise ou un circuit différent de celui du récepteur.
- Consulter un revendeur ou un technicien de radio ou télévision expérimenté.

Toute modification non expressément approuvée par Sennheiser electronic Corp. peut annuler le droit de l'utilisateur à l'emploi de l'équipement en question. Cet appareil numérique de la classe B est conforme à la norme NMB-003 du Canada.

### Sennheiser product warranty - FOR AUSTRALIA ONLY

Sennheiser's goods come with guarantees that cannot be excluded under the Australian Consumer Law. You are entitled to a replacement or refund for a major failure and compensation for any other reasonably foreseeable loss or damage. You are also entitled to have the goods repaired or replaced if the goods fail to be of acceptable quality and the failure does not amount to a major failure.

This warranty is in addition to other rights or remedies under law. Nothing in this warranty excludes, limits or modifies any liability of Sennheiser which is imposed by law, or limits or modifies any remedy available to the consumer which is granted by law.

To make a claim under this warranty, contact Sennheiser Australia Pty Ltd, Unit 3, 31 Gibbs Street Chatswood NSW 2067, AUSTRALIA  
Phone: (02) 9910 6700, email: [service@sennheiser.com.au](mailto:service@sennheiser.com.au). All expenses of claiming the warranty will be borne by the person making the claim.

The Sennheiser International Warranty is provided by Sennheiser Australia Pty Ltd (ABN 68 165 388 312), Unit 3, 31 Gibbs Street Chatswood NSW 2067 Australia.

For further information | Für weitere Informationen  
Pour plus d'informations | Yderligere information



For support go to  
[www.sennheiser.com/cco/support](http://www.sennheiser.com/cco/support)